

Name - _____

Start time - ___ : ___

End time - ___ : ___

Color the picture. Write the letters that represent the ending sounds of the picture below.

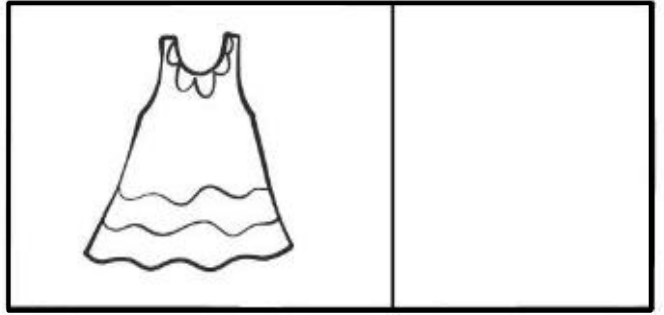
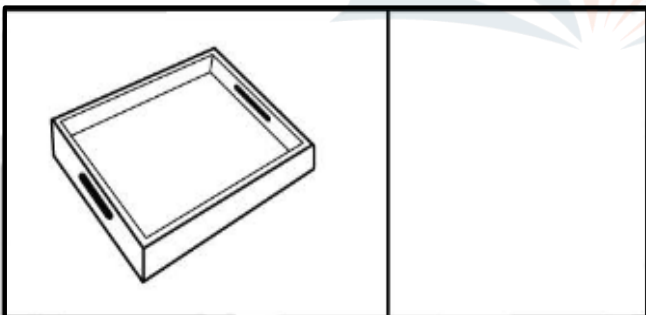
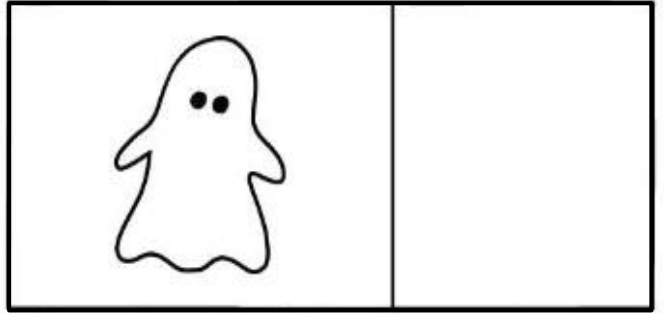
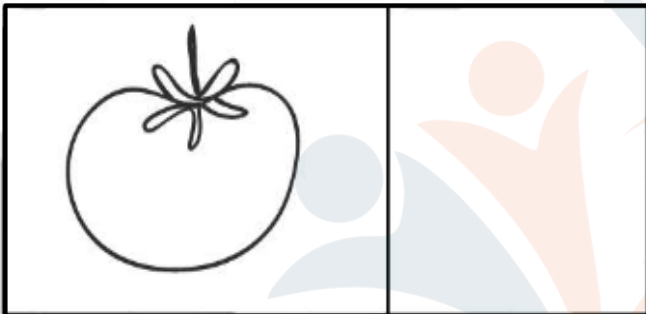
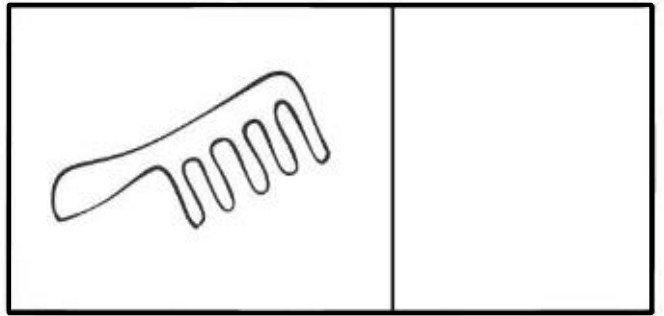
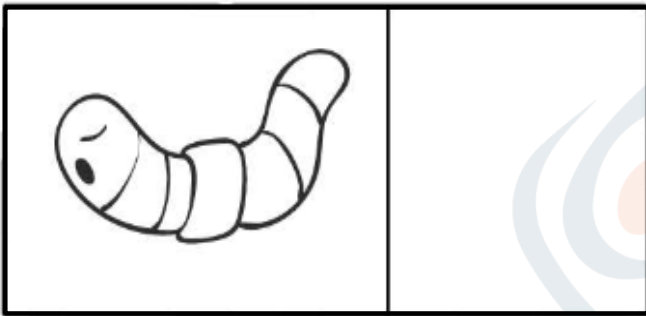
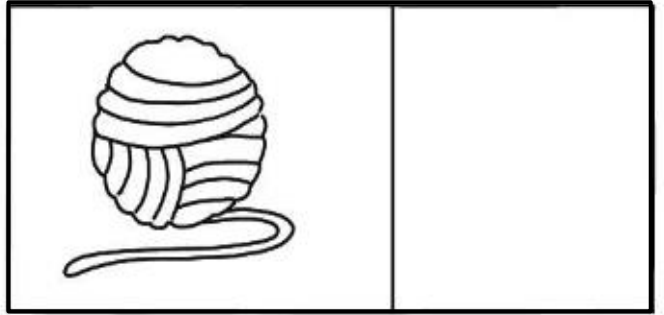
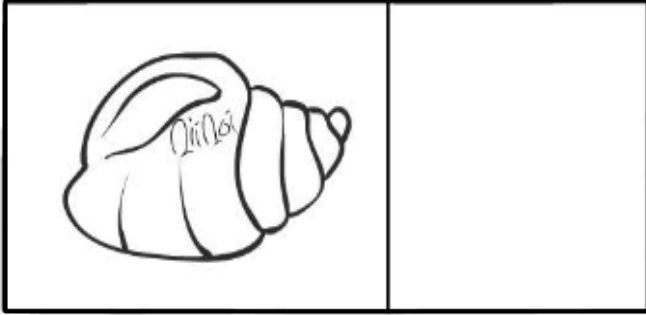

b	l	o	s	y	m	t	n
---	---	---	---	---	---	---	---

a b c d e f g h i j k l m n o p q r s t u v w x y z